

GLAT 슬라이딩 높은책장

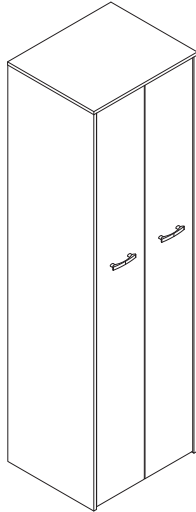

[취급주의]

- 가구사용시 인위적으로 휘발성있는 물질을 흘렸을 경우 가구표면의 손상이 발생하오니 주의하세요.
- 무리한 힘이나 충격을 가하지 마시고 수명을 유지하여 사용하세요.
- 직사광선이나 강한열 혹은 촉한을 피해주세요.
- 이동시 끌지마시고 들어서 이동하여 주세요.
- 테이프나 접착용품은 제품에 훼손을 일으킬수 있으니 주의하세요.
- 교환/취소/반품/환불 관련사항은 사이트 참조바랍니다.

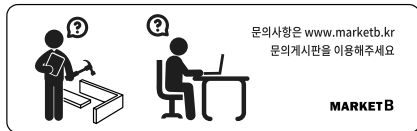
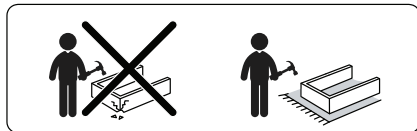

TIP

조립전 부품의 이상유무를 반드시 확인해주세요.

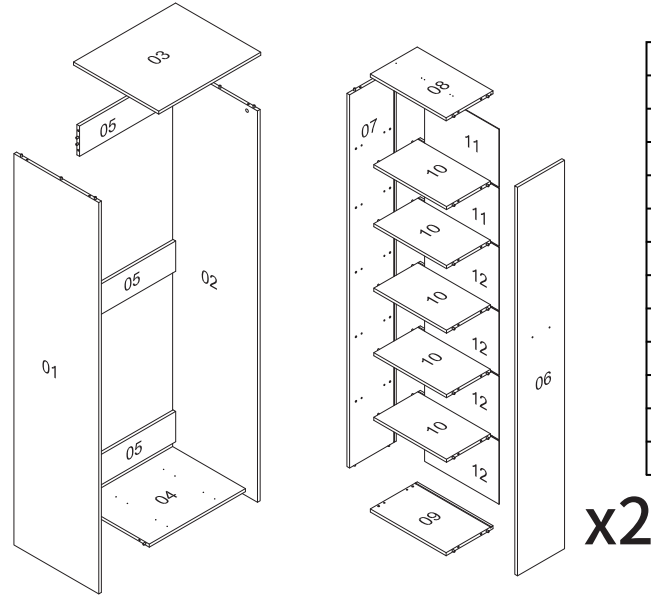

| 순서 | 부품명 | 수량 |
|----|---------|----|
| 1 | 왼쪽판 | 1 |
| 2 | 오른쪽판 | 1 |
| 3 | 상판 | 1 |
| 4 | 하판 | 1 |
| 5 | 뒤판 | 3 |
| 6 | 서랍 앞판 | 2 |
| 7 | 서랍 뒤판 | 2 |
| 8 | 서랍 상판 | 2 |
| 9 | 서랍 하판 | 2 |
| 10 | 서랍 중간판 | 10 |
| 11 | 서랍 옆판 1 | 4 |
| 12 | 서랍 옆판 2 | 8 |

| | 부품명 | 수량 | | 부품명 | 수량 | | 부품명 | 수량 |
|--|----------------------|----|--|--------------------|----|--|--------------------|----|
| | 001C 15 x 9.5mm | 52 | | 008C 4 x 16mm | 1 | | 017C 5.5 x 38mm | 24 |
| | 002C | 52 | | 009C 3.5 x 12mm | 32 | | 018C 4 x 15mm | 16 |
| | 003C | 4 | | 010C | 2 | | 019C | 4 |
| | 004C 400mm | 4 | | 011C 4 x 21mm | 4 | | | |
| | 005C 400mm | 4 | | 012C | 24 | | | |
| | 006C 6 x 13 x 1mm | 1 | | 013C 3 x 18mm | 24 | | | |
| | 007C | 1 | | 014C | 1 | | | |

※중요! 조립 전 확인해주세요.



슬라이드 레일러너 (부품번호 005C)



슬라이드 레일트랙(부품번호 004C)

위 이미지는 서랍 슬라이드레일의 레일러너와 레일트랙입니다.
운송 중 서랍 슬라이드 레일의 손상을 방지하기 위해 레일러너와 레일트랙은 1쌍씩 미리 조립되어있습니다.
제품 조립 전 레일러너를 레일트랙에서 분리해주세요.

1단계: 결합된 상태의 서랍 슬라이드 레일을 펼쳐주세요.

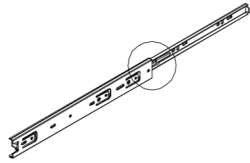

2단계: 레일러너의 플라스틱 잠금 레버를 누른 후 레일트랙과 레일러너를 양쪽으로 당겨 분리해주세요.

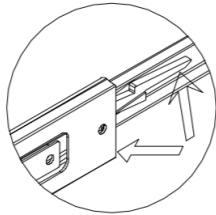

3단계: 레일트랙과 레일러너가 분리되었다면 위 과정을 반복하여 서랍 슬라이드 레일을 분리해주세요.

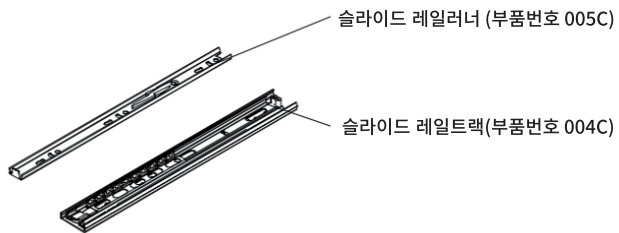

슬라이드 레일러너 (부품번호 005C)

슬라이드 레일트랙(부품번호 004C)

1

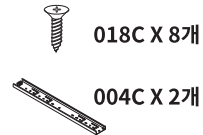
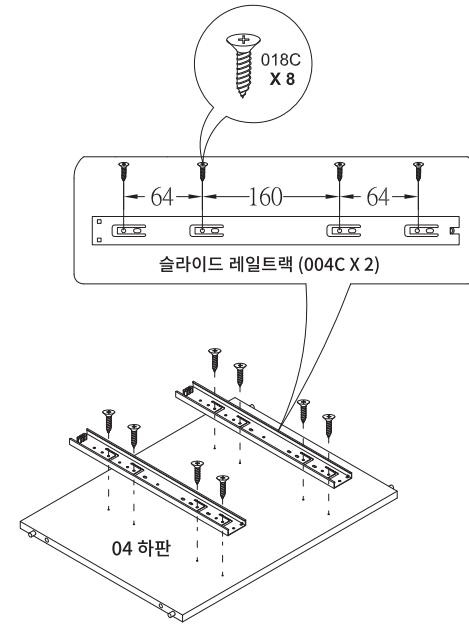

2

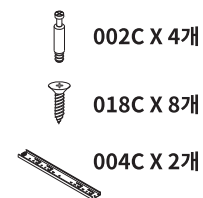
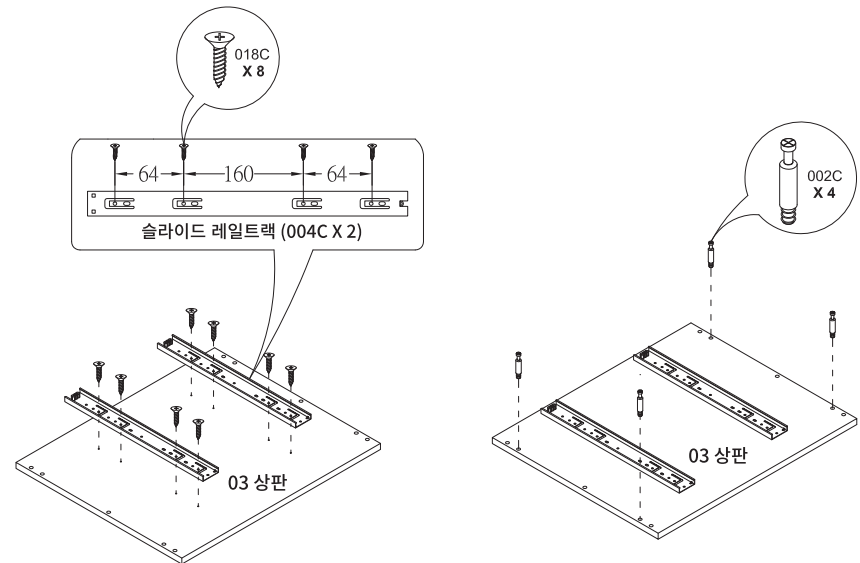

3

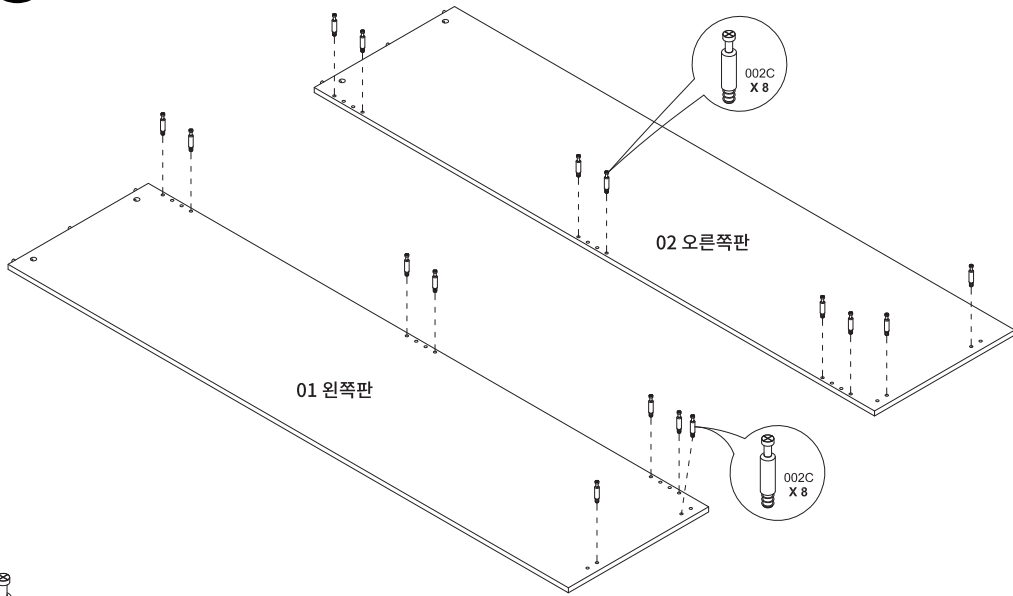

002C X 16개

4

※ 홀 가공 부분에 접착제를 도포해주세요.

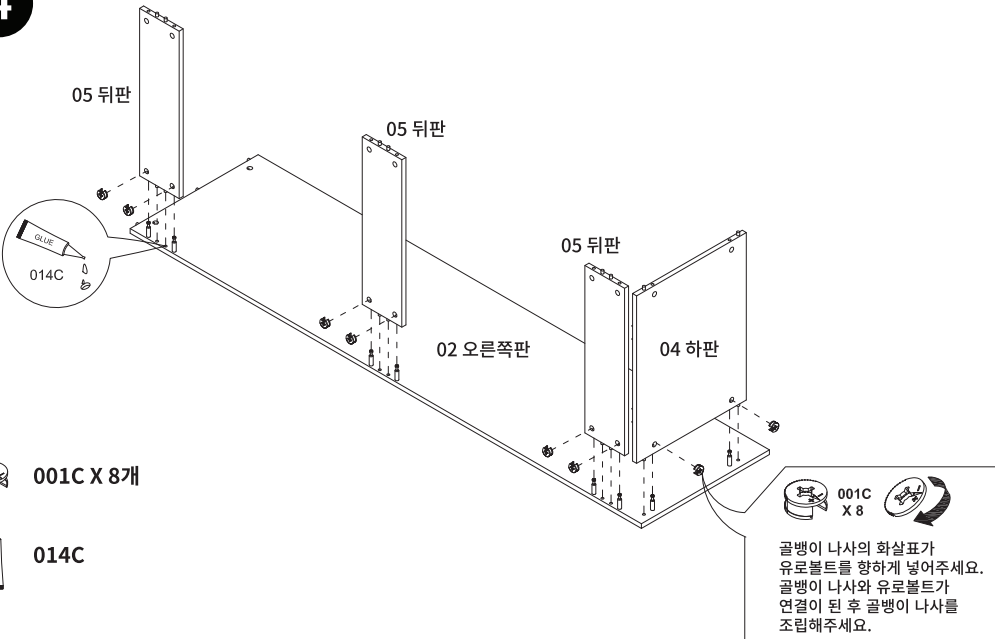

001C X 8개



014C

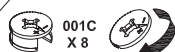

001C X 8

골뱅이 나사의 화살표가 유로볼트를 향하게 넣어주세요. 골뱅이 나사와 유로볼트가 연결이 된 후 골뱅이 나사를 조립해주세요.

3

MARKET B

※ 홀 가공 부분에 접착제를 도포해주세요.

5

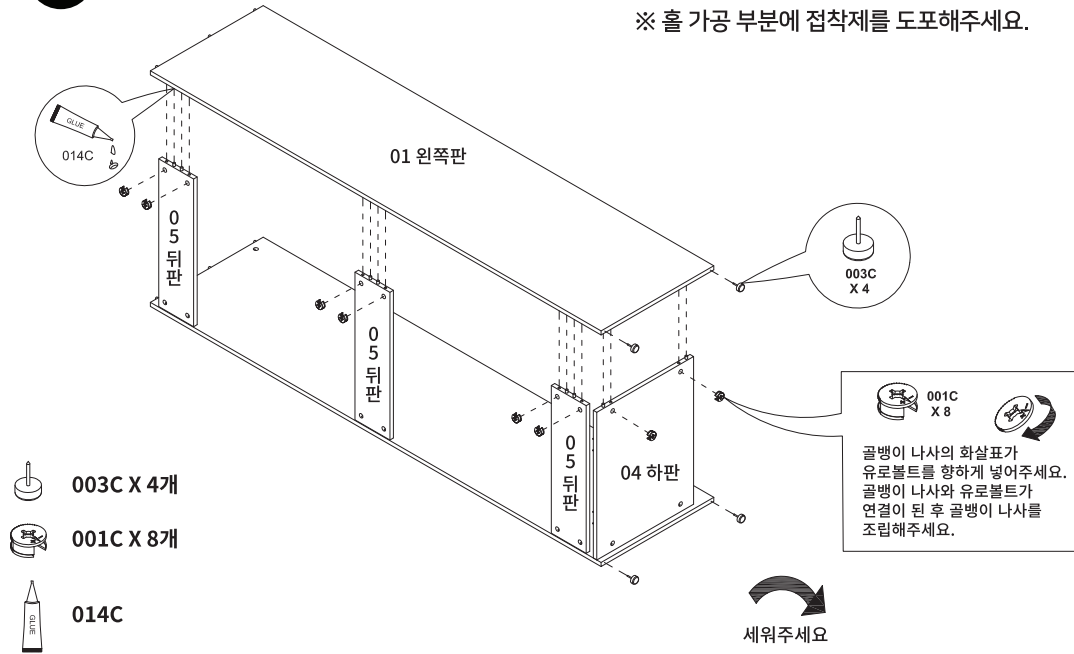

003C X 4개



001C X 8개



014C



세워주세요

6

※ 홀 가공 부분에 접착제를 도포해주세요.

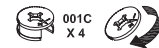
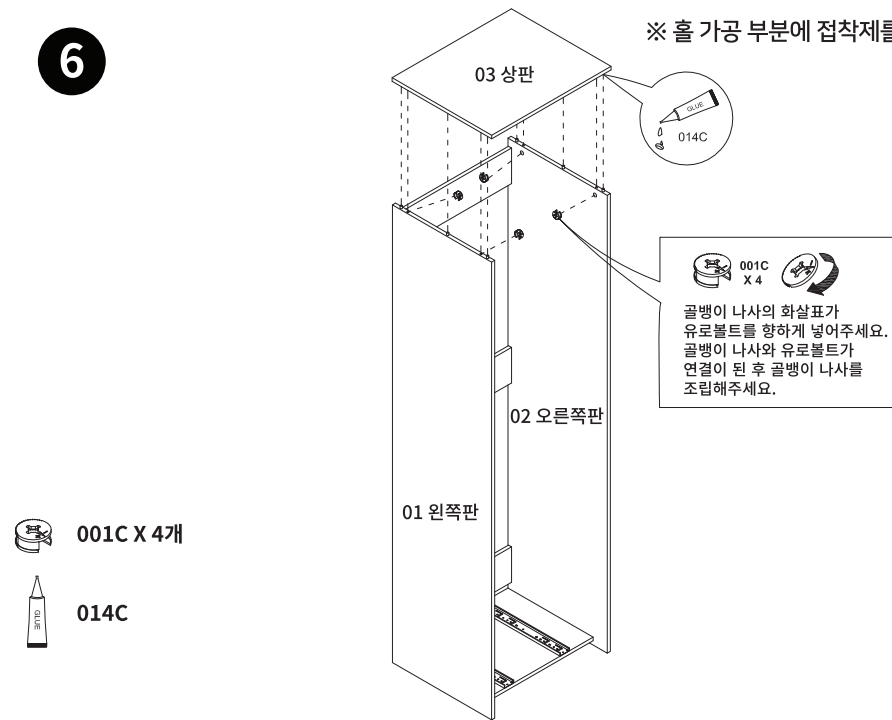

001C X 4

골뱅이 나사의 화살표가 유로볼트를 향하게 넣어주세요. 골뱅이 나사와 유로볼트가 연결이 된 후 골뱅이 나사를 조립해주세요.



001C X 4개



014C

7

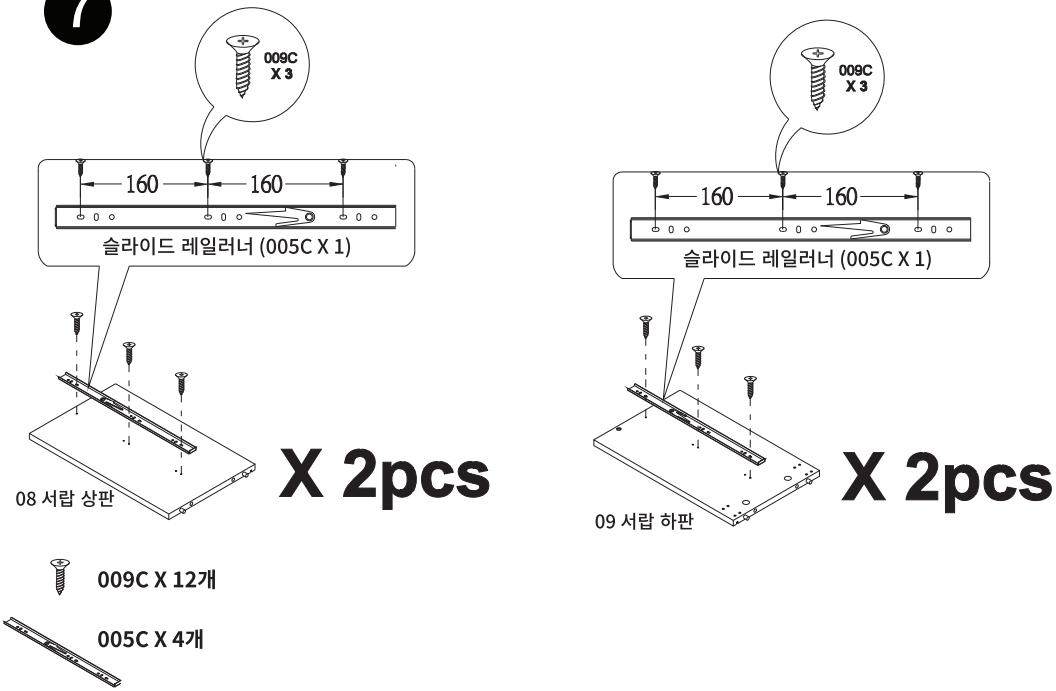

9

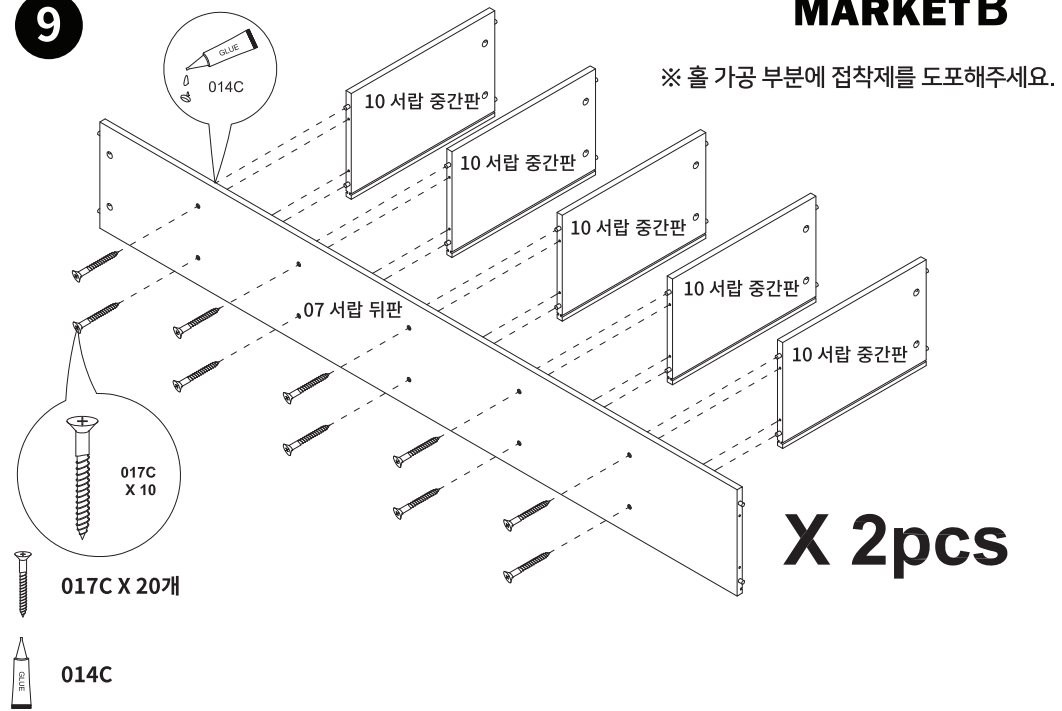

8

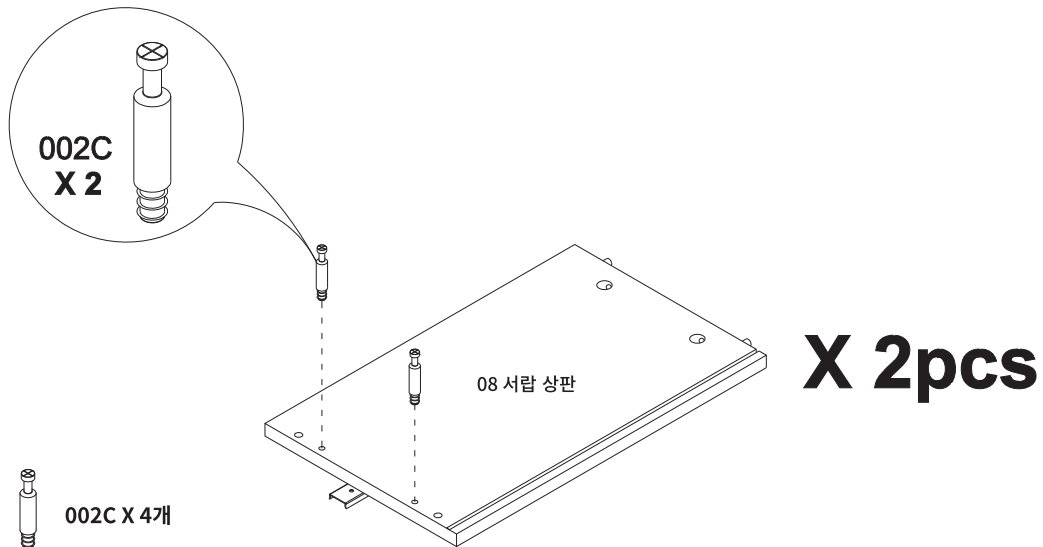

10

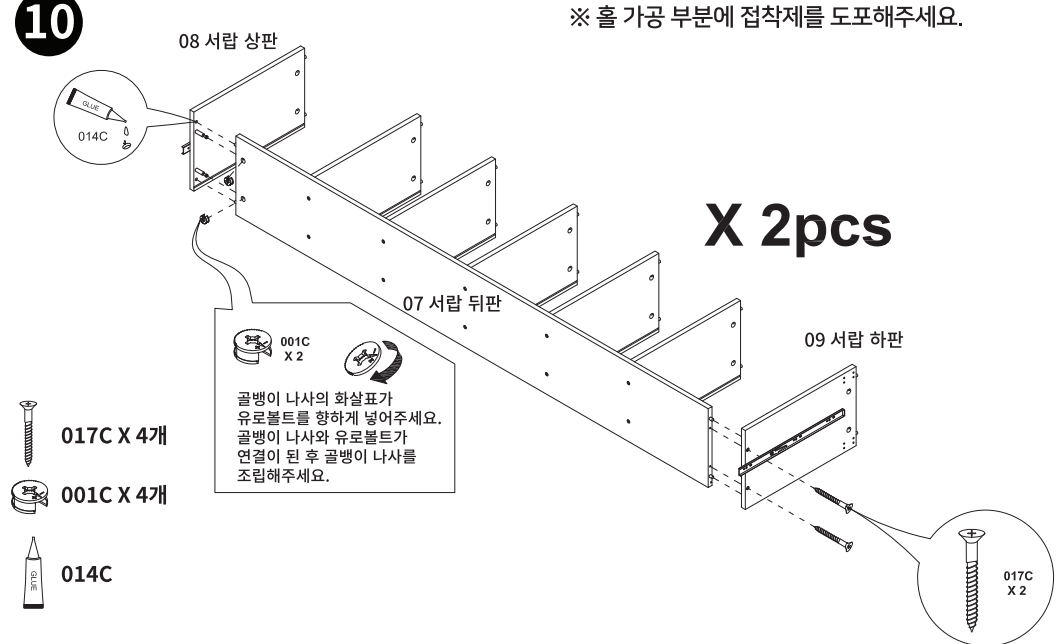

11

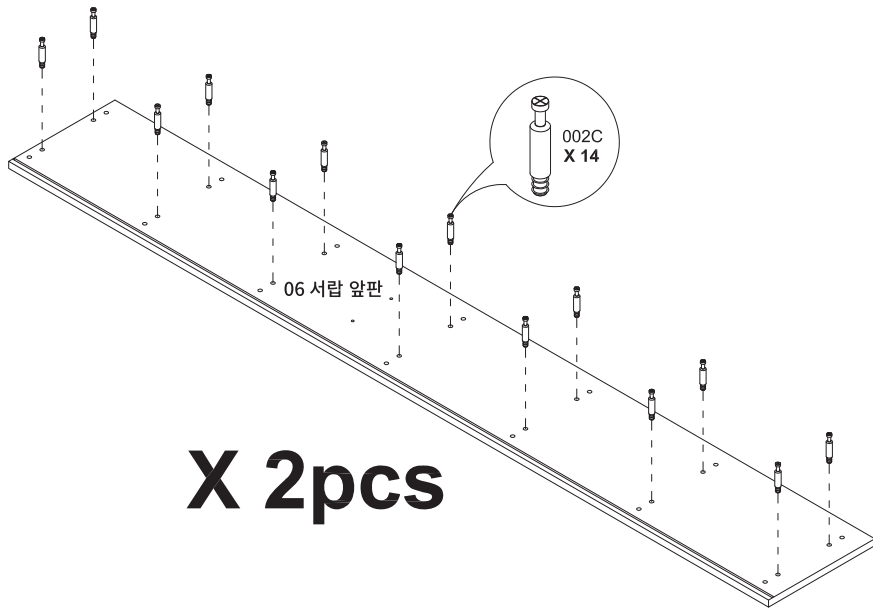

X 2pcs

- 002C X 28개

13

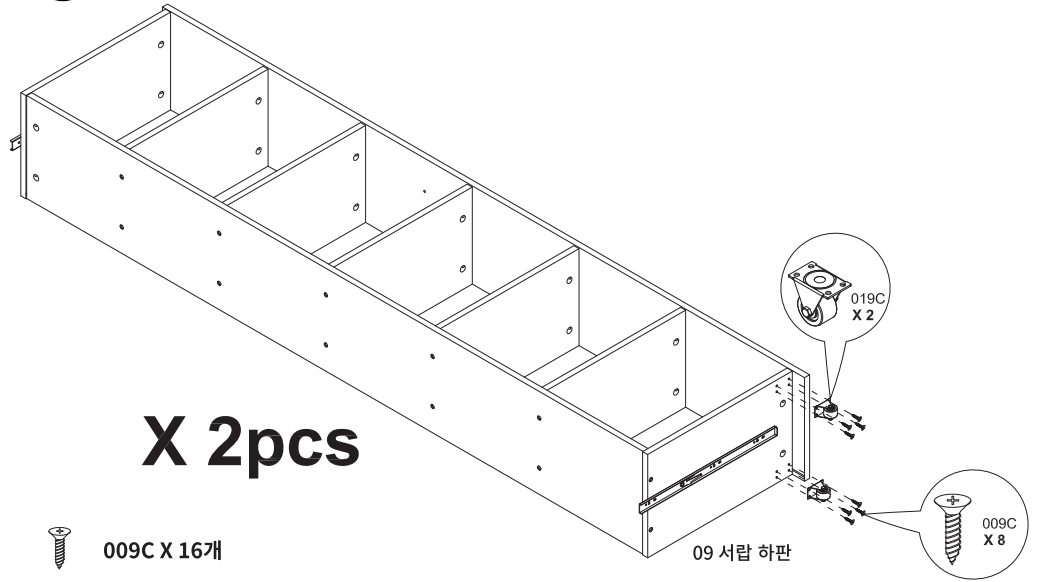

X 2pcs

- 009C X 16개
- 019C X 4개

12

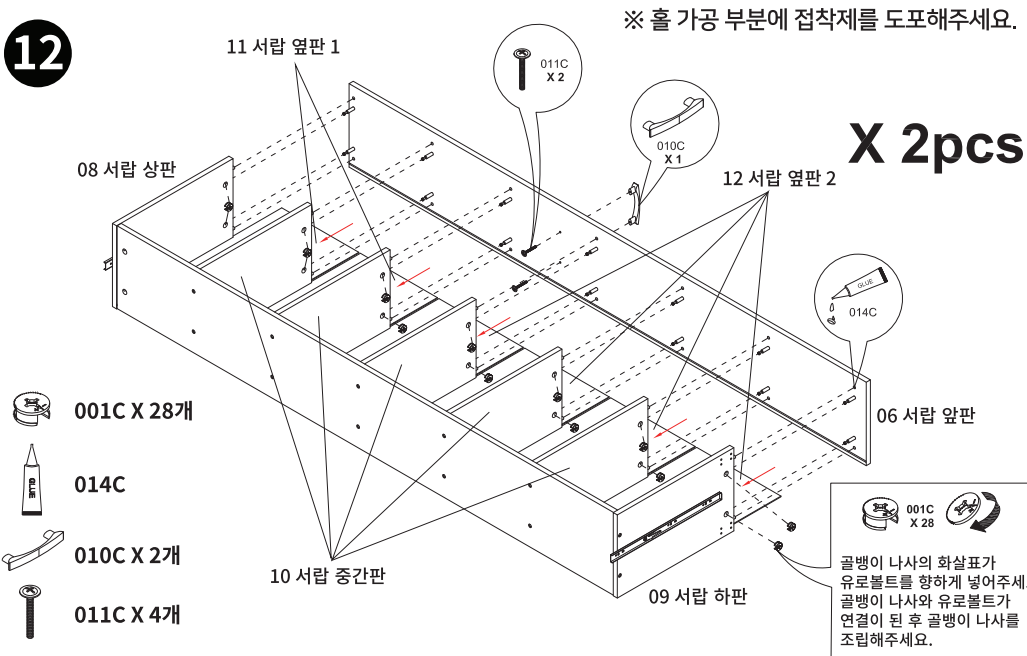

X 2pcs

- 001C X 28개
- 014C
- 010C X 2개
- 011C X 4개

001C X 28
 골뱅이 나사의 화살표가 유로볼트를 향하게 넣어주세요. 골뱅이 나사와 유로볼트가 연결이 된 후 골뱅이 나사를 조립해주세요.

14

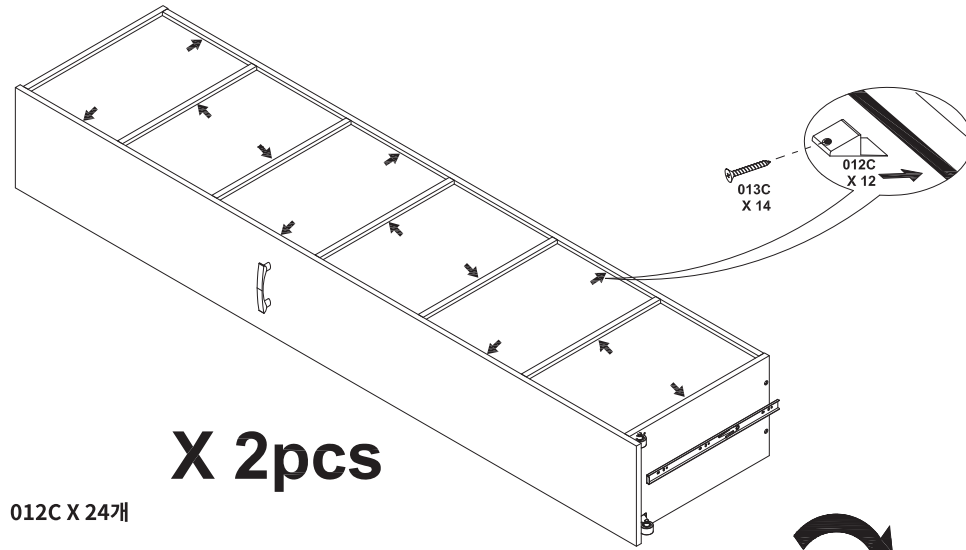

X 2pcs

- 012C X 24개
- 013C X 24개

세워주세요

15

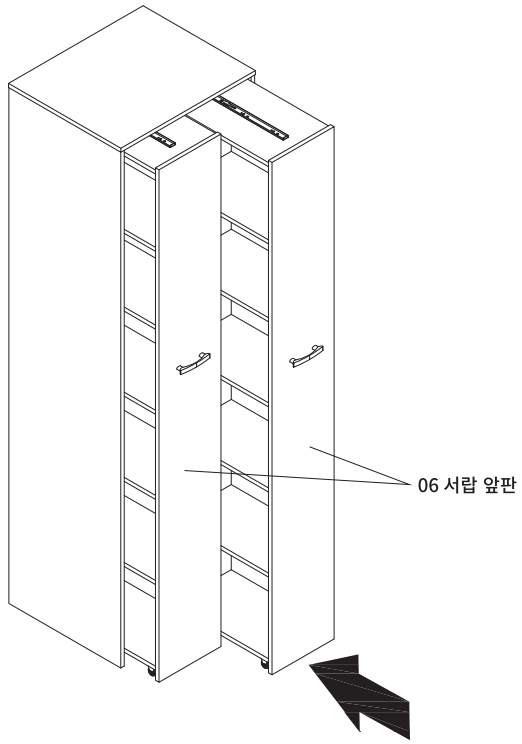

16

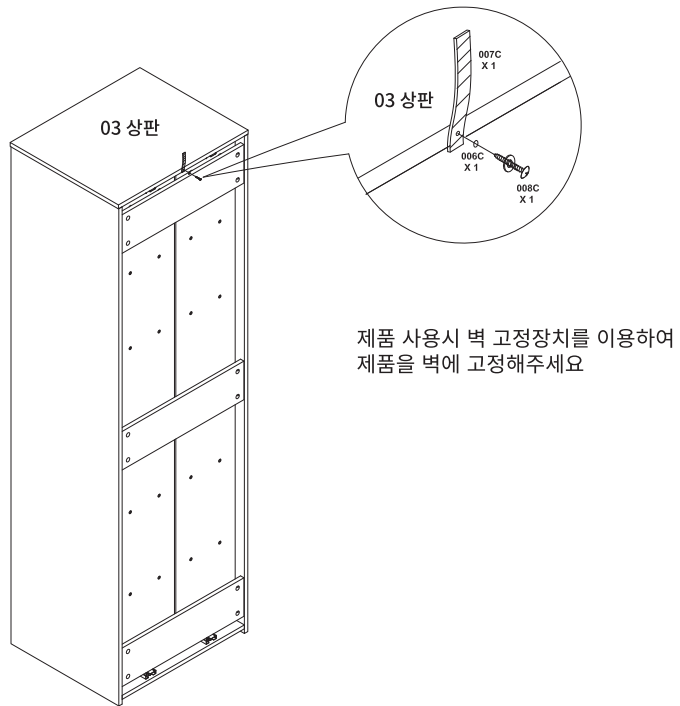

008C X 1개



006C X 1개



007C X 1개

17



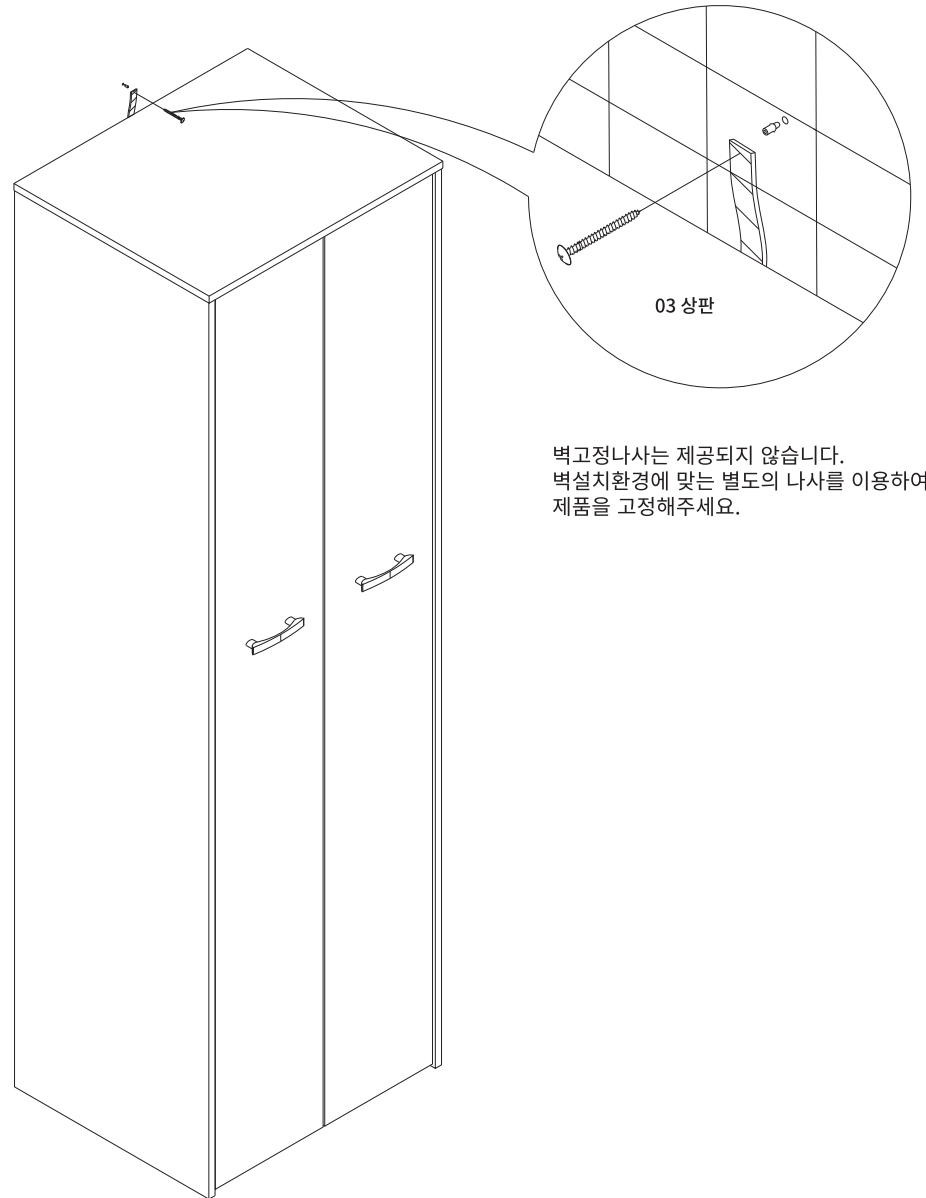













MARKET B



GLAT 슬라이딩 높은책장 포장구성

(1/2)

| 순서 | 부품명 | 수량 |
|----|---------|----|
| 3 | 상판 | 1 |
| 4 | 하판 | 1 |
| 5 | 뒤판 | 3 |
| 8 | 서랍 상판 | 2 |
| 9 | 서랍 하판 | 2 |
| 10 | 서랍 중간판 | 10 |
| 11 | 서랍 옆판 1 | 4 |
| 12 | 서랍 옆판 2 | 8 |

| | 부품명 | 수량 | | 부품명 | 수량 | | 부품명 | 수량 |
|---|----------------------|----|---|--------------------|----|--|--------------------|----|
|  | 001C 15 x 9.5mm | 52 |  | 008C 4 x 16mm | 1 |  | 017C 5.5 x 38mm | 24 |
|  | 002C | 52 |  | 009C 3.5 x 12mm | 32 |  | 018C 4 x 15mm | 16 |
|  | 003C | 4 |  | 010C | 2 |  | 019C | 4 |
|  | 004C 400mm | 4 |  | 011C 4 x 21mm | 4 | | | |
|  | 005C 400mm | 4 |  | 012C | 24 | | | |
|  | 006C 6 x 13 x 1mm | 1 |  | 013C 3 x 18mm | 24 | | | |
|  | 007C | 1 |  | 014C | 1 | | | |

(2/2)

| 순서 | 부품명 | 수량 |
|----|-------|----|
| 1 | 왼쪽판 | 1 |
| 2 | 오른쪽판 | 1 |
| 6 | 서랍 앞판 | 2 |
| 7 | 서랍 뒤판 | 2 |