

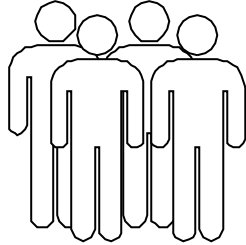

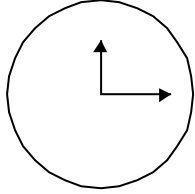

Assembly Instruction (DANARO DESK 10045)



- ①  Screw 4 Pcs + 1Pc
- ②  Screw 12 Pcs
- ③ 



Step I

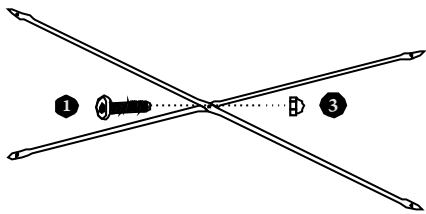

제일 길이가 긴 나사로 X 프레임을 먼저 조립해주세요.

Step II

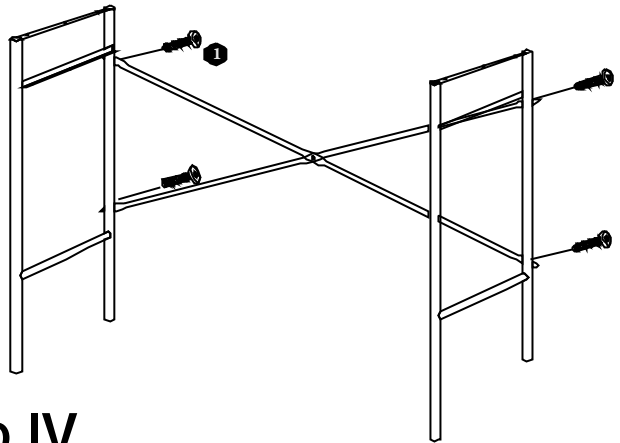

Step III

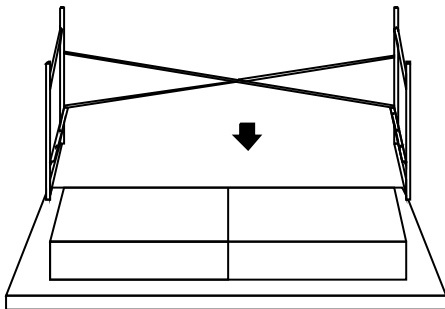

Step IV

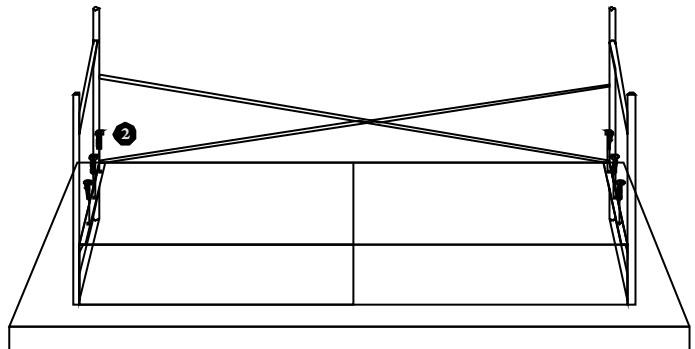

Step V

