

조립설명서

SIMPLIE

3단 수납장 BC124

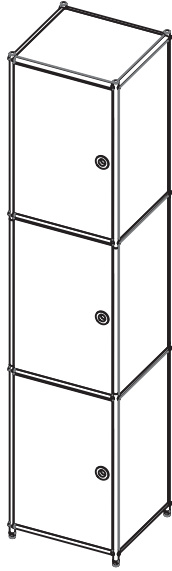

[취급주의]

- 가구사용시 인위적으로 휘발성있는 물질을 흘렸을 경우 가구표면의 손상이 발생하오니 주의하세요.
- 무리한 힘이나 충격을 가하지 마시고 수평을 유지하여 사용하세요.
- 직사광선이나 강한열 혹은 촉한을 피해주세요.
- 이동시 끌지마시고 들어서 이동하여 주세요.
- 테이프나 접착용품은 제품에 훼손을 일으킬수 있으니 주의하세요.
- 교환/취소/반품/환불 관련사항은 사이트 참조바랍니다.

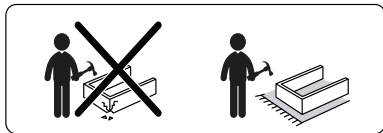

TIP

조립전 부품의 이상유무를 반드시 확인해주세요.

	부품명	수량
	(A) 캡	16
	(B) 나사1 (M6x45mm)	16
	(C) 육각렌치	1
	(D) 나사2 (M3x8mm)	36
	(E) 바닥패드	4
	(F) 힌지	6
	(G) 벽고정용나사 (M5x40mm)	2
	(H) 앵커볼트	2
	(I) 벽고정용 브라켓	2

	부품명	수량		부품명	수량
	① 상단 왼쪽,오른쪽 프레임/패널 1A: 상단 왼쪽,오른쪽 프레임 1B: 상단 왼쪽,오른쪽 패널	2		⑥ 중간 패널	2
	② 하단 왼쪽,오른쪽 프레임/패널 2A: 하단 왼쪽,오른쪽 프레임 2B: 하단 왼쪽,오른쪽 패널	2		⑦ 선반	3
	③ 중간프레임	4		⑧ 가로 프레임	8
	④ 뒤쪽 패널	3		⑨ 문	3
	⑤ 패널	4		⑩ 선반 부품	12

1 * 조립 전 프레임과 패널을 분리해 주세요.

① 상단 왼쪽,오른쪽 프레임/패널

1A:상단 왼쪽, 오른쪽 프레임

1B:상단 왼쪽, 오른쪽 패널

② 하단 왼쪽,오른쪽 프레임/패널

2A:하단 왼쪽, 오른쪽 프레임

2B:하단 왼쪽, 오른쪽 패널

2

1A ←

3 ←

3 ←

2A ←

(E) →

(E) →

1Ax2 (E)x4

2Ax2 ③x4

x2

3 * 각 프레임을 조립해주세요.

(A) →

(B) →

(C) →

8 →

(A)x16

(B)x16

(C)x1

⑧x8

4 * 조립순서

⑤ 패널 → ④ 뒤쪽 패널

⑤

④

④x3

⑤x4

5

상단 왼쪽,오른쪽 패널

⑥

하단 왼쪽,오른쪽 패널

상단 왼쪽,오른쪽 패널

⑥

하단 왼쪽,오른쪽 패널

⑥x2

6

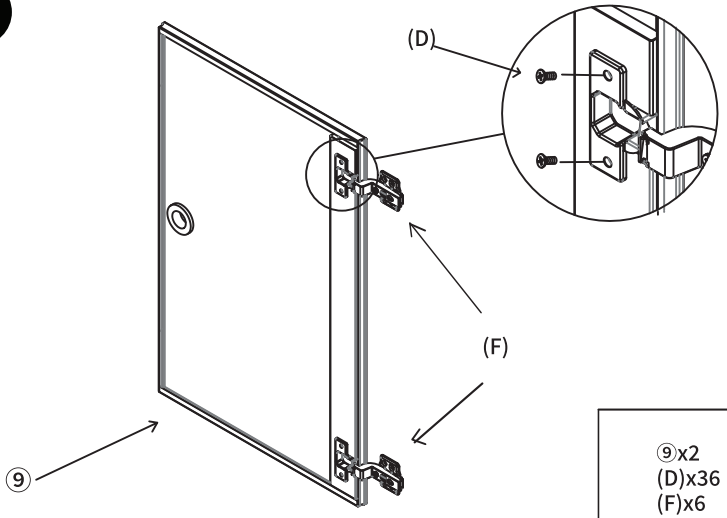

⑨x2
 (D)x36
 (F)x6

7

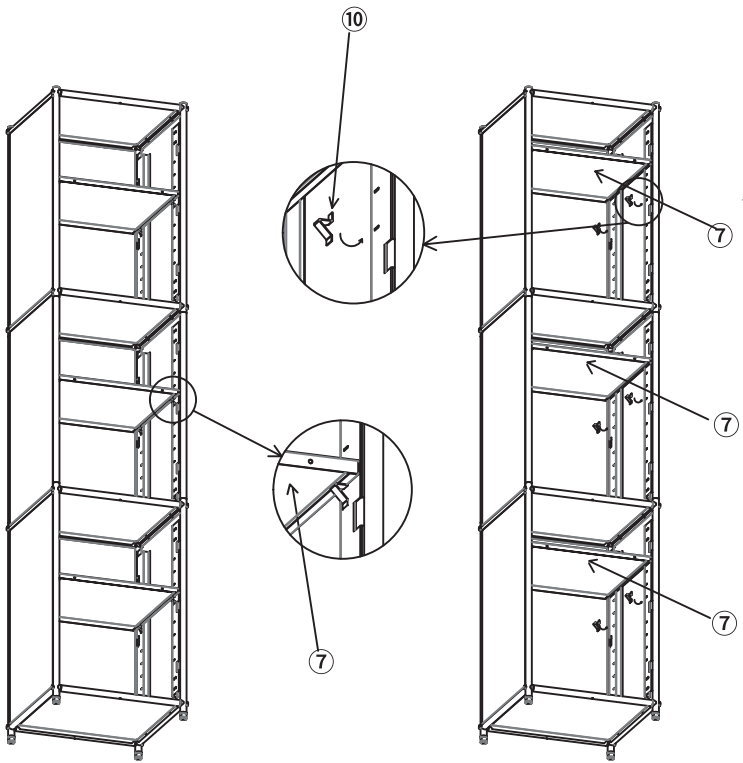

⑦x3
 ⑩x12

8

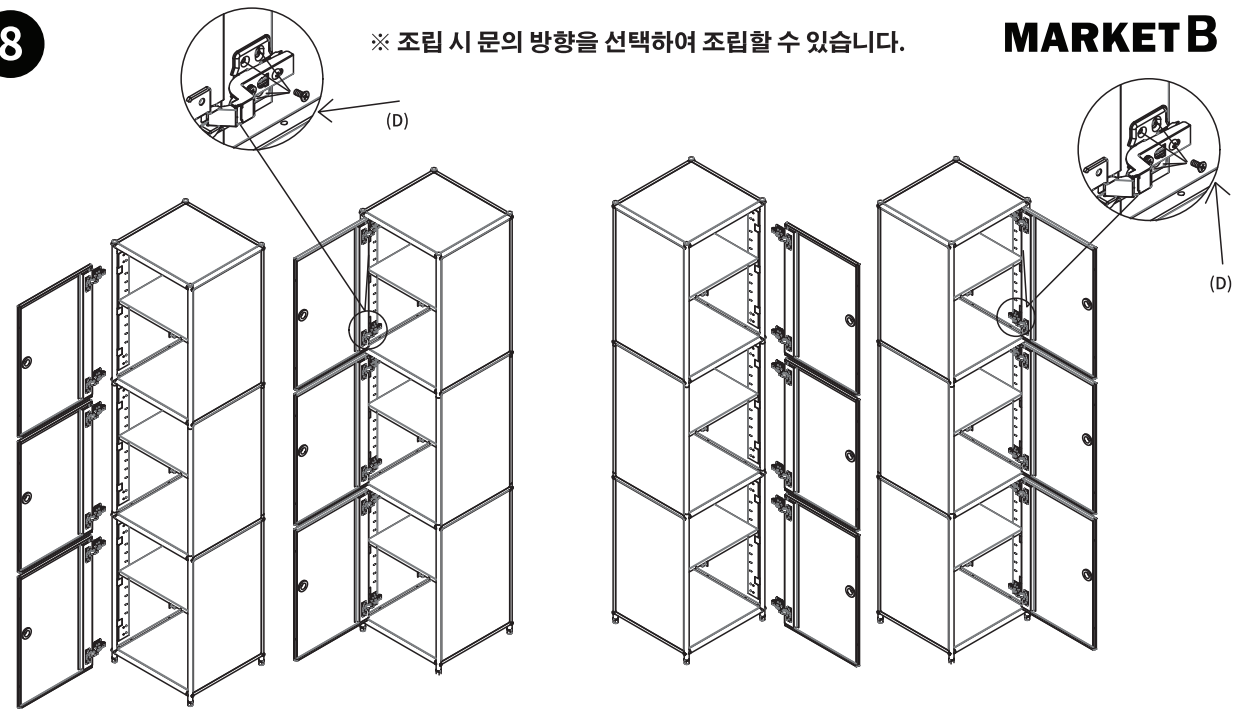

※ 조립 시 문의 방향을 선택하여 조립할 수 있습니다.

MARKET B

손잡이 오른쪽 위치



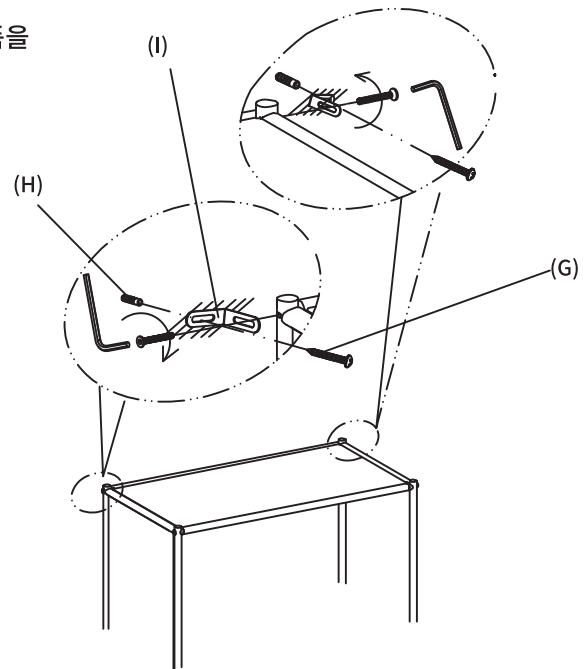

손잡이 왼쪽 위치

*동봉된 브라켓을 사용하여 벽에 제품을 고정 후 사용해주세요.



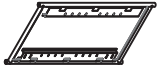
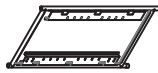

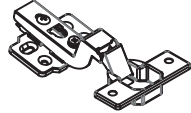



SIMPLIE 3단 수납장 BC124 포장방법

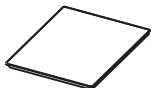

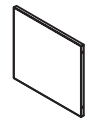
3-1

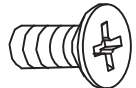
	①	2		②	2
	③	4		(H)	2
	(F)	6		(I)	2
	(G) M5x40mm	2			

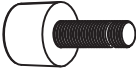
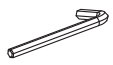
3-2

	⑤	4		(B) M6x45mm	16
	⑦	3		(A)	16
	⑧	8		(D) M3x8mm	36
	⑩	12		(E)	4
	(C)	1			

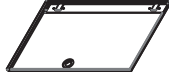
3-3

	⑨	3		④	3
	⑥	2			